

 **Koblenz**[®]

JANITORIAL PRODUCTS

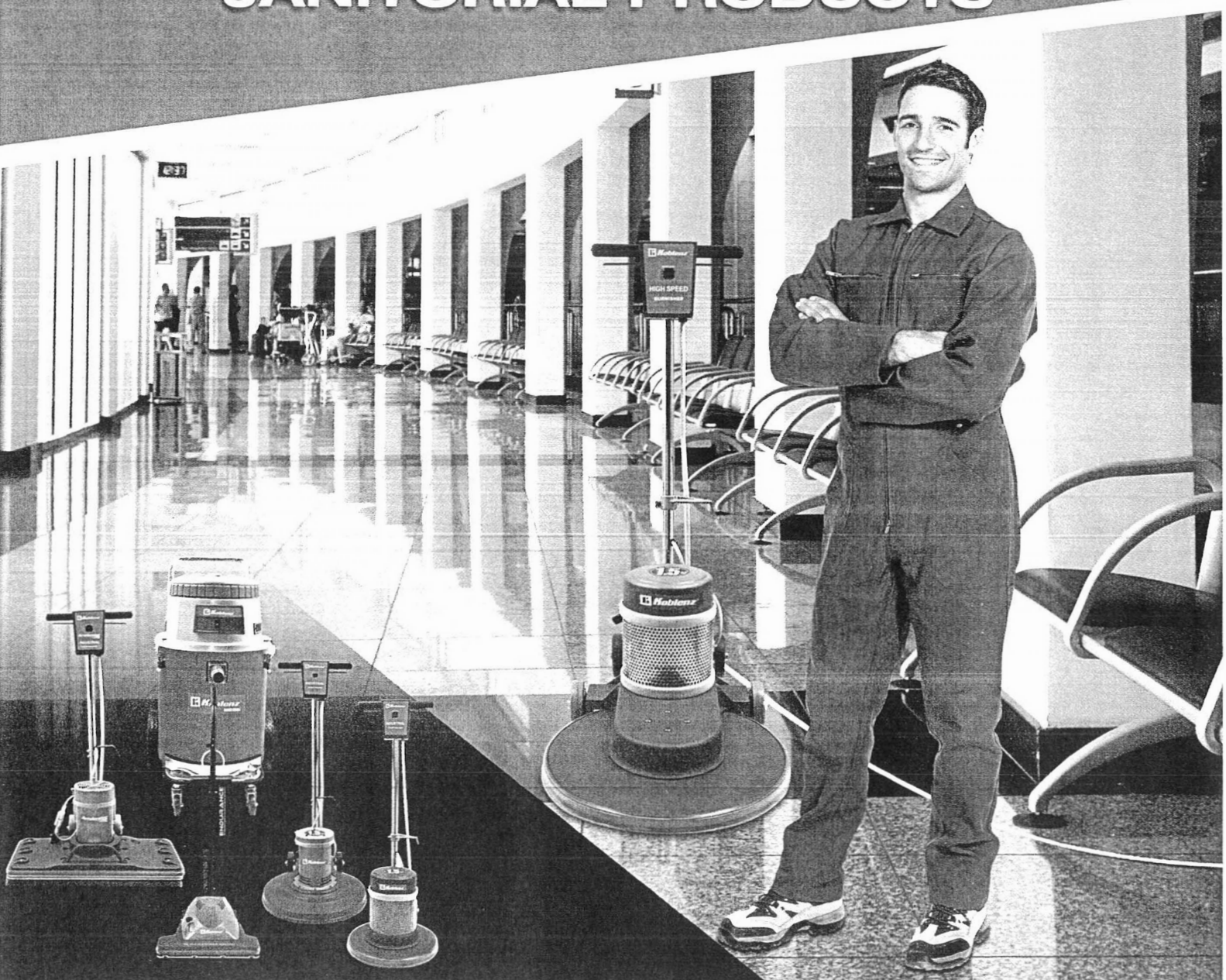

Don't compromise, get the best!

Commercial Floor Machines



**TP-1715 N
TP-2015 N
TP2S-2015 N**

Ball bearing wheels



SP-15 N

Ball bearing wheels

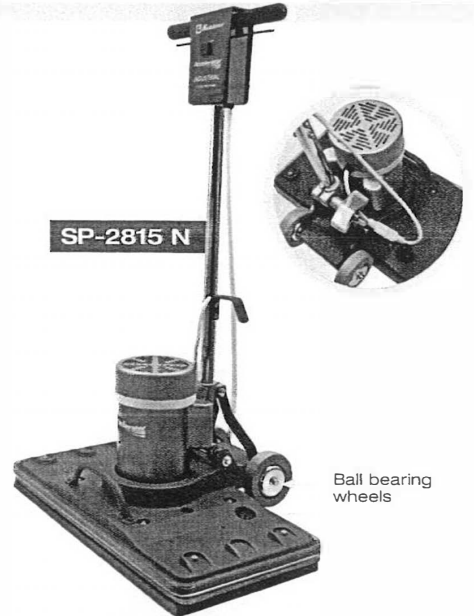

SP-2815 N

Ball bearing wheels

Durable all metal construction

Triple planetary all steel gears

High performance motor.

Cast iron heavy weight chassis for best performance.

Safety switch and locking mechanism.

MODEL	BRUSH SPEED	PAD SIZE	MOTOR	SHIPPING WEIGHT	NET WEIGHT	CONSTRUCTION
TP-1715 N	175 RPM	17 in	1.5 HP ♦	123 lbs	96 lbs	Cast iron & steel
TP-2015 N	175 RPM	20 in	1.5 HP ♦	125 lbs	106 lbs	
TP2S-2015 N	320/175 RPM	20 in	1.5 HP D.C.	120 lbs	101 lbs	
SP-15 N	3500 RPM	20" x 14"	1.5 HP ♦	84 lbs	61 lbs	Cast iron
SP-2815 N	3500 RPM	28" x 14"	1.5 HP ♦	106 lbs	81 lbs	
RM-1715 N	175 RPM	17 in	1.5 HP	110 lbs	86 lbs	High impact polyethylene
RM-2015 N	175 RPM	20 in	1.5 HP	136 lbs	111 lbs	Cast aluminum
DP-1334 N	175 RPM	13 in	3/4 HP	160 lbs	135 lbs	Cast aluminum
TP-1715-AU N	175 RPM	17 in	1.5 HP ♦	122 lbs	104 lbs	Cast iron & steel
TP-2015-AU N	175 RPM	20 in	1.5 HP ♦	124 lbs	106 lbs	

5 year limited warranty. * Excludes wear items. ♦ Dual capacitor.



**RM-1715 N
RM-2015 N**



DP-1334 N
DP model is double planetary.



**TP-1715-AU N
TP-2015-AU N**

Commercial High Speed Burnishers

B-1500-FP N

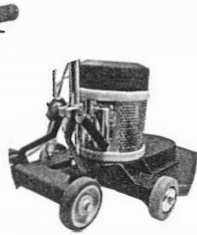

*Long life carbonless induction motor.
Safety switch and locking mechanism.
Circuit breaker protects electrical installation.*

Ball bearing wheels

	B-1500-P N	B-1500-FP N	B-1500-C N Dust control	B-1500-FC N Dust control
HANDLE	Fixed handle	Floating handle	Fixed handle	Floating handle
DUST CONTROL SYSTEM				
PAD SIZE	20 inches	20 inches	20 inches	20 inches
MOTOR		Precision balanced powerful 1.5 HP A.C. twin capacitor		
CIRCUIT BREAKER	YES	YES	YES	YES
POWER CORD		50 Ft. 3 wire grounded 14 gauge		
TRANSPORT WHEELS		Four 5 inch. non-marking		
SHIPPING WEIGHT	106 lbs	127 lbs	108 lbs	129 lbs
NET WEIGHT w/o CABLE	98 lbs	120 lbs	102 lbs	122 lbs
CONSTRUCTION		Cast aluminum and steel		
5 year limited warranty. * Excludes wear items.				

Fast Burnishing with less effort!

Upright Vacuum Cleaners **ENDURANCE**[®]



* Applies to all Zipper models with HEPA bags.

**U-40 N
U-80 N**

U-90 N

SERIES	Dump bag	Zipper bag F&G	Zipper bag HEPA F&G	Zipper bag Type A	Zipper bag HEPA Type A	Dust cup
Available in any of the following options:						

MODEL	AMPS	CFM	NET WEIGHT	SHIPPING WEIGHT	BAG CAPACITY	EXTRA FEATURES	CORD LENGTH	PIG TAIL
U-40 N	5.0	120	11.4 lbs	17.6 lbs	18 Qts	Ultra low operation (63.3 dB)	35 ft	No
U-80 N	7.0	125	11.6 lbs	17.95 lbs	18 Qts	Low noise operation (67.4 dB)	50 ft	Yes
U-90 N	7.0	125	13.2 lbs	19.6 lbs	18 Qts	Low noise operation (67.4 dB)	50 ft	Yes

*One year limited warranty for commercial use.

Low maintenance design-easy access to belt and brush roll for quick servicing.

Quick change pig tail / line cord on U-80 & U-90.

Powerful twin ball bearing motor.

Commercial Wet/Dry Vacuum Cleaners

Optional Accessories:



28" front mount squeegee



Kit B/P (00-3973-5)



Kit C/P (00-3974-3)



HEPA & FILTER disposable bags



AI-1260 P N

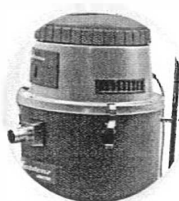

- Hospital Quiet
- Rugged Construction

MODEL	TOTAL CAPACITY	RECOVERABLE CAPACITY	AMPS	CORD LENGTH	CFM	TANK	DRAIN HOSE	NET WEIGHT	SHIPPING WEIGHT	dB
AI-1260 P N	12 Gal	8 Gal	9.0	35 ft	96	Rotomolded	No	46 lbs	61 lbs	68
AI-1660 P N	16 Gal	12 Gal	9.0	35 ft	96	Rotomolded	Yes	51 lbs	63 lbs	68
AI-1960 P N	19 Gal	16 Gal	9.0	35 ft	96	Rotomolded	Yes	53 lbs	66 lbs	68

One year limited warranty for commercial use Five year warranty on rotomolded tank

Reinforced caster wheels.

10" wheels.

Steel motor housing - epoxy powder painted.

Drain hose makes emptying the vacuum very easy.

Rugged rotomolded poly tank, resistant to corrosion.

Powerful 9 Amp. 2 stage twin ball bearing motor.

Clean Air Uprights

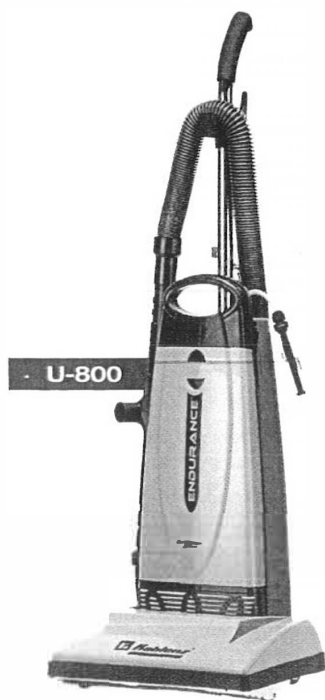

U-800



U-900

MODEL	WATTS	THERMAL RESET	NET WEIGHT	SHIPPING WEIGHT	CORD LENGTH	PIG TAIL	EXTRA FEATURES
U-800	1000	Yes	19.3 lbs	24.5 lbs	50 ft	Yes	Quick draw hose
U-900	1000	Yes	19.3 lbs	24.5 lbs	50 ft	Yes	HEPA filtration

One year limited warranty

On board tools

Quick change pig tail / line cord.

Rugged construction.

Superior filtration.

Clean air motor system that filters the air before it reaches the motor.

Ideal for cleaning hotels, restaurants, offices and much more.

Easy to operate.

HEPA Vacuum Cleaners

Hand Vac



Backpack

Low maintenance line cord can be replaced in seconds.
Full padded shoulder straps assure worker comfort.
Easy to replace disposable filter bag.
Superior cleaning efficiency up to 7000 sq. ft. per hour.

BP-1400

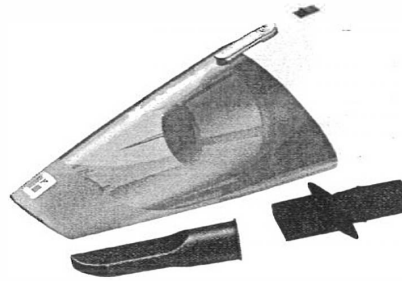

Powerful 400 watt motor.
17 ft. line cord.
Easy to clean.
Washable hermetic filter.

HV-120 KG3

MODEL	AMPS	CFM	DUST CAPACITY	NET WEIGHT	SHIPPING WEIGHT	CORD LENGTH	PIG TAIL
BP-1400	8.5	120	6 Qts	11 lbs	25 lbs	50 ft	Yes

One year limited warranty on parts and labor.

THE CLEANING MACHINE

Portable Washer

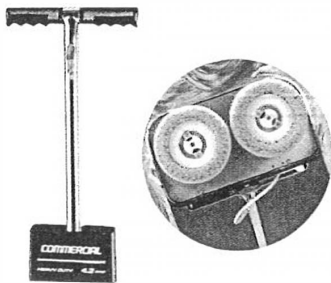

P-4000

Twin counter rotation brushes.
Deep cleans carpet spots and stains.
Scrubs hardfloors in small tight areas.
Ideal for small and hard to reach places.



MODEL	AMPS	LINE CORD	TANK CAPACITY	ACCESSORIES INCLUDED	CLEANING PATH	NET WEIGHT	SHIPPING WEIGHT	PRODUCT DIMENSIONS
P-4000 00-274-3	4.2	35' Grounded	120 Oz	Carpet brushes	12"	16 lbs	21 lbs	L 13 in W 7 in H 44 in

One year limited warranty on parts and labor.



LCK60

No need to send microfibers out for laundering.
Wash on site 6 lbs of microfibers, bonnets, rags or mops in 5 minutes*.
Compact size, it can be stored on-site!

MODEL	CAPACITY	CONTROLS	TYPE OF AGITATION	DRAIN	NET WEIGHT	SHIPPING WEIGHT	PRODUCT DIMENSIONS
LCK60 00-3080-9	13.2 lbs	Automatic Shut off timer (up to 15 mins)	Reversible impeller on bottom	Gravity	22 lbs	28.6 lbs	L 16.15 in W 17.72 in H 31.89 in

One year limited warranty on parts and labor.

Wet / Dry Vacuum Cleaners



WD-2.5K US



WD-354 K2G US



WD-6K2 US



WD-9K2 US



WD-12K US



WD-16K US

Contractor tested

Rugged construction

Handy air blower

MODEL	WD-2.5K US	WD-354 K2G US	WD-6K2 US	WD-9K2 US	WD-12K US	WD-16K US
Capacity	2.5 gallon	3 gallon	6 gallon	9 gallon	12 gallon	16 gallon
Peak H.P.	1.75	1.75	3.0	4.0	5.5	6.5
Line cord	6 ft	6 ft	10 ft	10 ft	15 ft.	18 ft
Wheels	No	No	Yes	Yes	Yes	Yes
Hose Diam	1 ¼"	1 ¼"	1 7/8"	1 7/8"	2 ½"	2 ½"
Accessories	3	7	6	6	6	6



Thorne Electric Company, P.O. Box 18363
San Antonio, Tx 78218-0363
Tel: 1(800) 548•5741, (210) 590•1226
Fax: (210) 590-1258

www.koblenz-electric.com